

# FDS8812NZ

## N-Channel PowerTrench® MOSFET

30V, 20A, 4.0mΩ

### Features

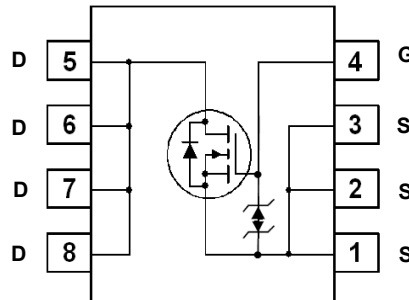
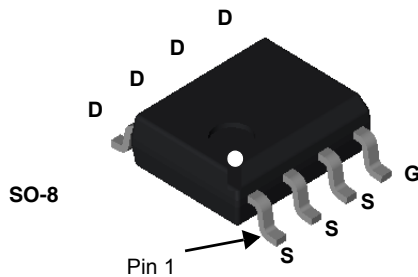
- Max  $r_{DS(on)}$  = 4.0mΩ at  $V_{GS} = 10V$ ,  $I_D = 20A$
- Max  $r_{DS(on)}$  = 4.9mΩ at  $V_{GS} = 4.5V$ ,  $I_D = 18A$
- HBM ESD protection level of 6.4kV typical (note 3)
- High performance trench technology for extremely low  $r_{DS(on)}$
- High power and current handling capability
- RoHS compliant



### General Description

This N-Channel MOSFET is produced using Fairchild Semiconductor's advanced PowerTrench® process that has been especially tailored to minimize the on-state resistance.

This device is well suited for Power Management and load switching applications common in Notebook Computers and Portable Battery Packs.



### MOSFET Maximum Ratings $T_A = 25^\circ\text{C}$ unless otherwise noted

Symbol	Parameter	Ratings	Units
$V_{DS}$	Drain to Source Voltage	30	V
$V_{GS}$	Gate to Source Voltage	$\pm 20$	V
$I_D$	Drain Current -Continuous (Note 1a)	20	A
	-Pulsed	80	
$E_{AS}$	Single Pulse Avalanche Energy (Note 4)	661	mJ
$P_D$	Power Dissipation (Note 1a)	2.5	W
	Power Dissipation (Note 1b)	1.0	
$T_J, T_{STG}$	Operating and Storage Junction Temperature Range	-55 to +150	$^\circ\text{C}$

### Thermal Characteristics

$R_{\theta JC}$	Thermal Resistance, Junction to Case (Note 1)	25	$^\circ\text{C/W}$
$R_{\theta JA}$	Thermal Resistance, Junction to Ambient (Note 1a)	50	
$R_{\theta JA}$	Thermal Resistance, Junction to Ambient (Note 1b)	125	

### Package Marking and Ordering Information

Device Marking	Device	Reel Size	Tape Width	Quantity
FDS8812NZ	FDS8812NZ	13"	12mm	2500 units

## Electrical Characteristics $T_J = 25^\circ\text{C}$ unless otherwise noted

Symbol	Parameter	Test Conditions	Min	Typ	Max	Units
--------	-----------	-----------------	-----	-----	-----	-------

### Off Characteristics

$BV_{DSS}$	Drain to Source Breakdown Voltage	$I_D = 250\mu\text{A}$ , $V_{GS} = 0\text{V}$	30			V
$\frac{\Delta BV_{DSS}}{\Delta T_J}$	Breakdown Voltage Temperature Coefficient	$I_D = 250\mu\text{A}$ , referenced to $25^\circ\text{C}$		19		mV/ $^\circ\text{C}$
$I_{DSS}$	Zero Gate Voltage Drain Current	$V_{DS} = 24\text{V}$ , $V_{GS} = 0\text{V}$			1	$\mu\text{A}$
$I_{GSS}$	Gate to Source Leakage Current	$V_{GS} = \pm 20\text{V}$ , $V_{DS} = 0\text{V}$			$\pm 10$	$\mu\text{A}$

### On Characteristics (Note 2)

$V_{GS(th)}$	Gate to Source Threshold Voltage	$V_{GS} = V_{DS}$ , $I_D = 250\mu\text{A}$	1	1.8	3	V
$\frac{\Delta V_{GS(th)}}{\Delta T_J}$	Gate to Source Threshold Voltage Temperature Coefficient	$I_D = 250\mu\text{A}$ , referenced to $25^\circ\text{C}$		-7		mV/ $^\circ\text{C}$
$r_{DS(on)}$	Static Drain to Source On Resistance	$V_{GS} = 10\text{V}$ , $I_D = 20\text{A}$		3.1	4.0	m $\Omega$
		$V_{GS} = 4.5\text{V}$ , $I_D = 18\text{A}$		3.8	4.9	
		$V_{GS} = 10\text{V}$ , $I_D = 20\text{A}$ , $T_J = 125^\circ\text{C}$		4.2	5.3	
$g_{FS}$	Forward Transconductance	$V_{DS} = 5\text{V}$ , $I_D = 20\text{A}$		87		S

### Dynamic Characteristics

$C_{iss}$	Input Capacitance	$V_{DS} = 15\text{V}$ , $V_{GS} = 0\text{V}$ , $f = 1\text{MHz}$		5205	6925	pF
$C_{oss}$	Output Capacitance			945	1260	pF
$C_{rss}$	Reverse Transfer Capacitance			580	870	pF
$R_g$	Gate Resistance		$f = 1\text{MHz}$		1.5	

### Switching Characteristics

$t_{d(on)}$	Turn-On Delay Time	$V_{DD} = 15\text{V}$ , $I_D = 20\text{A}$ $V_{GS} = 10\text{V}$ , $R_{GEN} = 6\Omega$		18	33	ns
$t_r$	Rise Time			13	24	ns
$t_{d(off)}$	Turn-Off Delay Time			55	88	ns
$t_f$	Fall Time			12	22	ns
$Q_g$	Total Gate Charge	$V_{GS} = 0\text{V}$ to $10\text{V}$	$V_{DD} = 15\text{V}$ $I_D = 20\text{A}$	90	126	nC
$Q_g$	Total Gate Charge	$V_{GS} = 0\text{V}$ to $5\text{V}$		49	69	nC
$Q_{gs}$	Gate to Source Charge			16		nC
$Q_{gd}$	Gate to Drain "Miller" Charge			18		nC

### Drain-Source Diode Characteristics

$V_{SD}$	Source to Drain Diode Forward Voltage	$V_{GS} = 0\text{V}$ , $I_S = 2.1\text{A}$ (Note 2)		0.7	1.2	V
$t_{rr}$	Reverse Recovery Time	$I_F = 20\text{A}$ , $di/dt = 100\text{A}/\mu\text{s}$		36	54	ns
$Q_{rr}$	Reverse Recovery Charge			33	50	nC

#### Notes:

- $R_{\theta JA}$  is the sum of the junction-to-case and case-to-ambient thermal resistance where the case thermal reference is defined as the solder mounting surface of the drain pins.  $R_{\theta JC}$  is guaranteed by design while  $R_{\theta JA}$  is determined by the user's board design.



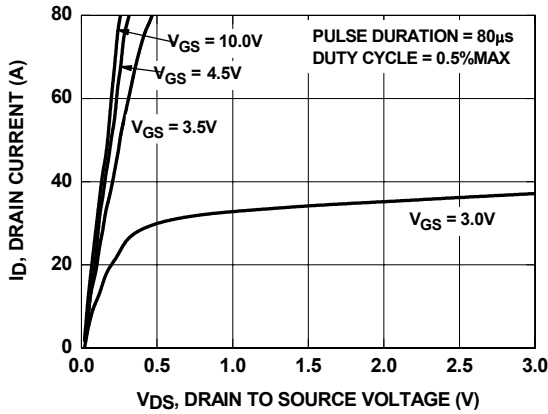
a)  $50^\circ\text{C}/\text{W}$  when mounted on a  $1\text{in}^2$  pad of 2 oz copper.



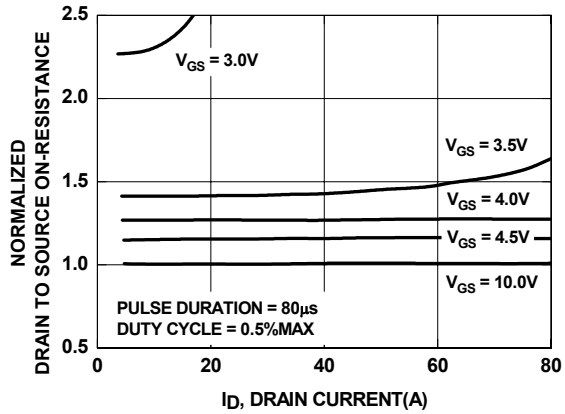
b)  $125^\circ\text{C}/\text{W}$  when mounted on a minimum pad.

- Pulse Test: Pulse Width < 300  $\mu\text{s}$ , Duty Cycle < 2%.
- The diode connected between the gate and source serves only as protection against ESD. No gate overvoltage rating is implied.
- Starting  $T_J = 25^\circ\text{C}$ ,  $L = 3\text{mH}$ ,  $I_{AS} = 21\text{A}$ ,  $V_{DD} = 30\text{V}$ ,  $V_{GS} = 10\text{V}$ .

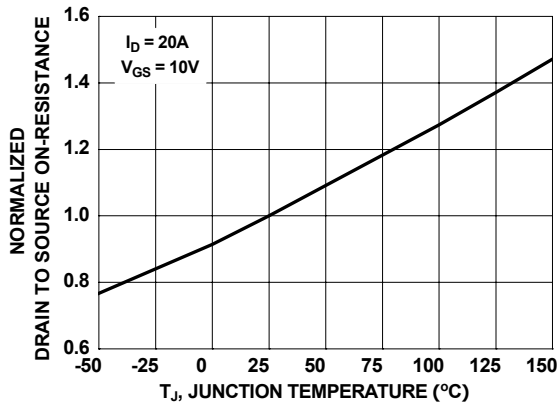
**Typical Characteristics**  $T_J = 25^\circ\text{C}$  unless otherwise noted



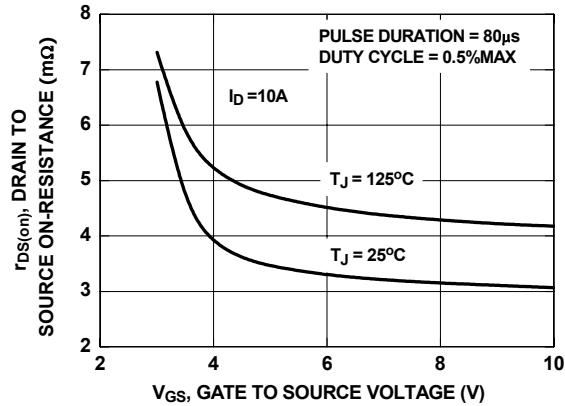
**Figure 1. On-Region Characteristics**



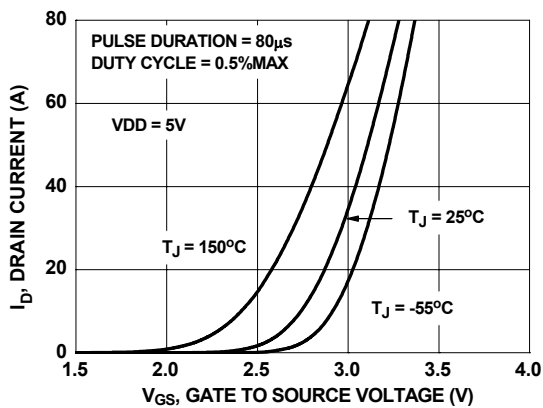
**Figure 2. Normalized On-Resistance vs Drain Current and Gate Voltage**



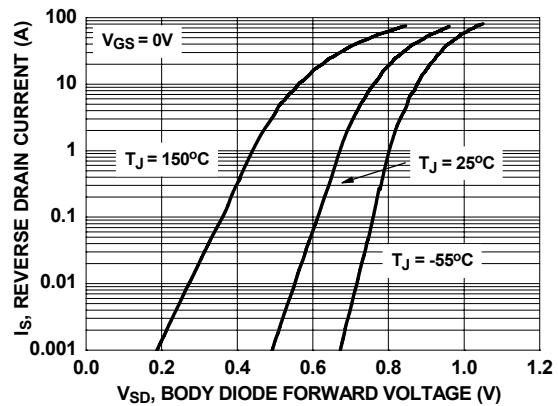
**Figure 3. Normalized On-Resistance vs Junction Temperature**



**Figure 4. On-Resistance vs Gate to Source Voltage**

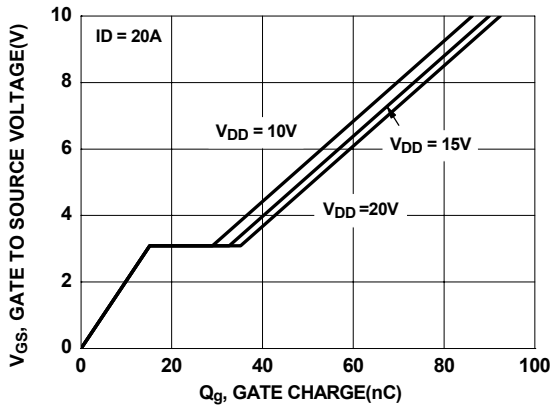


**Figure 5. Transfer Characteristics**

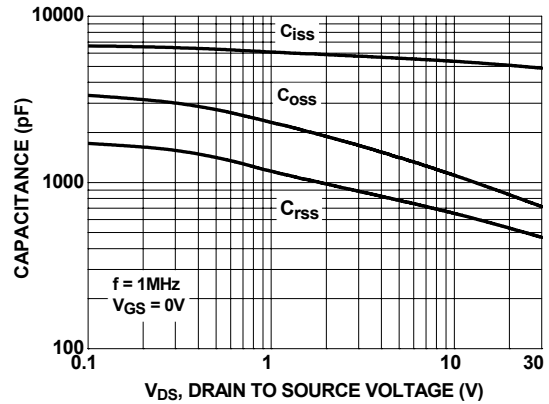


**Figure 6. Source to Drain Diode Forward Voltage vs Source Current**

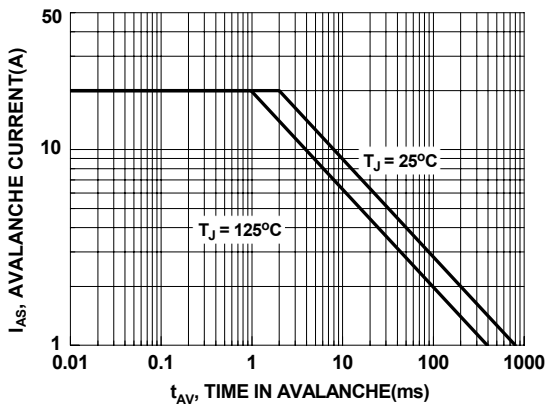
**Typical Characteristics**  $T_J = 25^\circ\text{C}$  unless otherwise noted



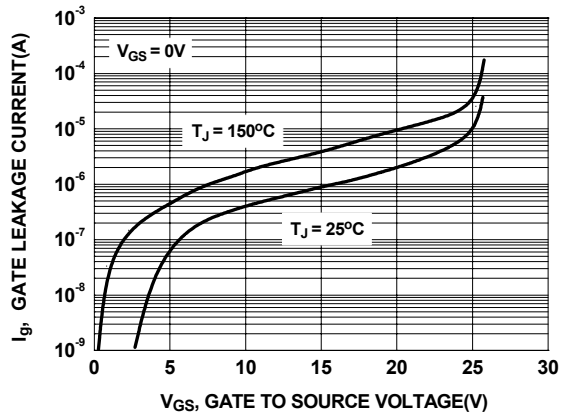
**Figure 7. Gate Charge Characteristics**



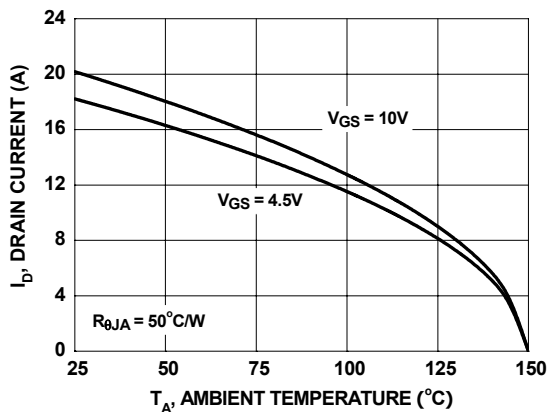
**Figure 8. Capacitance vs Drain to Source Voltage**



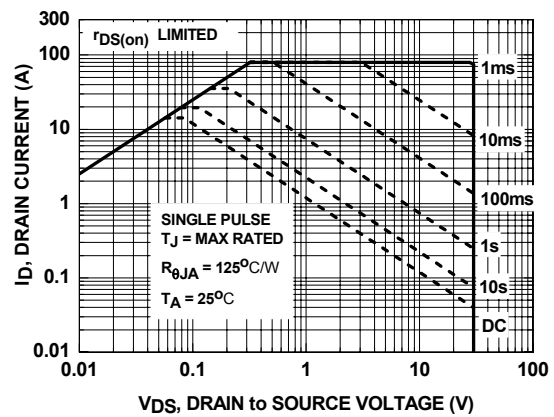
**Figure 9. Unclamped Inductive Switching Capability**



**Figure 10. Gate Leakage Current vs Gate to Source Voltage**

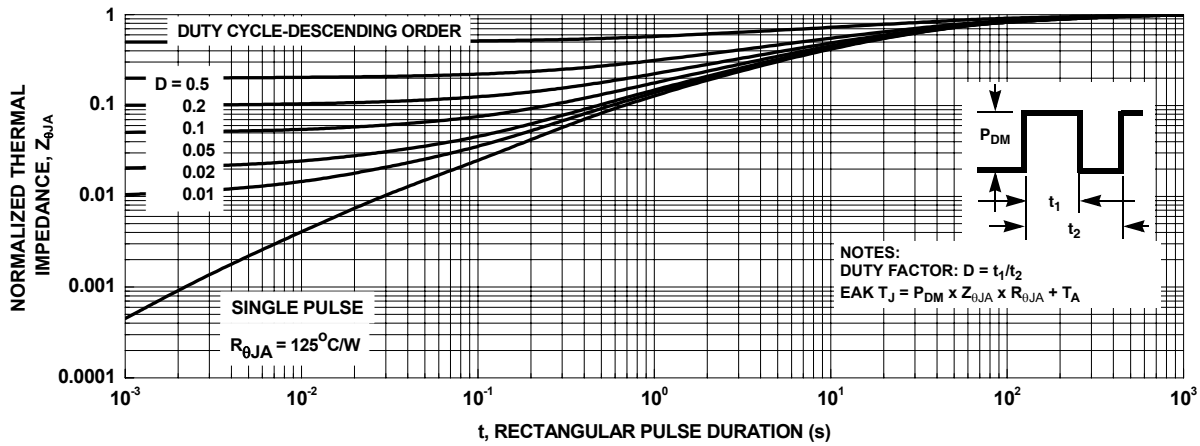
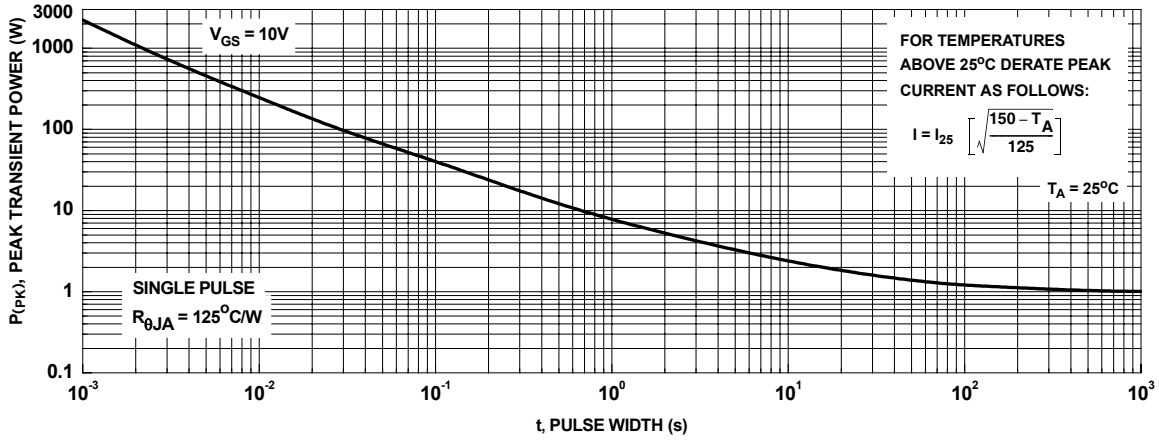


**Figure 11. Maximum Continuous Drain Current vs Ambient Temperature**



**Figure 12. Forward Bias Safe Operating Area**


**Typical Characteristics**  $T_J = 25^\circ\text{C}$  unless otherwise noted





**TRADEMARKS**

The following are registered and unregistered trademarks Fairchild Semiconductor owns or is authorized to use and is not intended to be an exhaustive list of all such trademarks.

ACEx®	HiSeC™	Programmable Active Droop™	TinyLogic®
Across the board. Around the world.™	i-Lo™	QFET®	TINYOPTO™
ActiveArray™	ImpliedDisconnect™	QS™	TinyPower™
Bottomless™	IntelliMAX™	QT Optoelectronics™	TinyWire™
Build it Now™	ISOPLANAR™	Quiet Series™	TruTranslation™
CoolFET™	MICROCOUPLER™	RapidConfigure™	µSerDes™
CROSSVOLT™	MicroPak™	RapidConnect™	UHC®
CTL™	MICROWIRE™	ScalarPump™	UniFET™
Current Transfer Logic™	MSX™	SMART START™	VCX™
DOME™	MSXPro™	SPM®	Wire™
E <sup>2</sup> CMOS™	OCX™	STEALTH™	
EcoSPARK®	OCXPro™	SuperFET™	
EnSigna™	OPTOLOGIC®	SuperSOT™-3	
FACT Quiet Series™	OPTOPLANAR®	SuperSOT™-6	
FACT®	PACMAN™	SuperSOT™-8	
FAST®	POP™	SyncFET™	
FASTr™	Power220®	TCM™	
FPS™	Power247®	The Power Franchise®	
FRFET®	PowerEdge™	 ™	
GlobalOptoisolator™	PowerSaver™	TinyBoost™	
GTO™	PowerTrench®	TinyBuck™	

**DISCLAIMER**

FAIRCHILD SEMICONDUCTOR RESERVES THE RIGHT TO MAKE CHANGES WITHOUT FURTHER NOTICE TO ANY PRODUCTS HEREIN TO IMPROVE RELIABILITY, FUNCTION OR DESIGN. FAIRCHILD DOES NOT ASSUME ANY LIABILITY ARISING OUT OF THE APPLICATION OR USE OF ANY PRODUCT OR CIRCUIT DESCRIBED HEREIN; NEITHER DOES IT CONVEY ANY LICENSE UNDER ITS PATENT RIGHTS, NOR THE RIGHTS OF OTHERS. THESE SPECIFICATIONS DO NOT EXPAND THE TERMS OF FAIRCHILD'S WORLDWIDE TERMS AND CONDITIONS, SPECIFICALLY THE WARRANTY THEREIN, WHICH COVERS THESE PRODUCTS.

**LIFE SUPPORT POLICY**

FAIRCHILD'S PRODUCTS ARE NOT AUTHORIZED FOR USE AS CRITICAL COMPONENTS IN LIFE SUPPORT DEVICES OR SYSTEMS WITHOUT THE EXPRESS WRITTEN APPROVAL OF FAIRCHILD SEMICONDUCTOR CORPORATION.

As used herein:

1. Life support devices or systems are devices or systems which, (a) are intended for surgical implant into the body or (b) support or sustain life, and (c) whose failure to perform when properly used in accordance with instructions for use provided in the labeling, can be reasonably expected to result in a significant injury of the user.
2. A critical component in any component of a life support device, or system whose failure to perform can be reasonably expected to cause the failure of the life support device or system, or to affect its safety or effectiveness.

**PRODUCT STATUS DEFINITIONS**

**Definition of Terms**

Datasheet Identification	Product Status	Definition
Advance Information	Formative or In Design	This datasheet contains the design specifications for product development. Specifications may change in any manner without notice.
Preliminary	First Production	This datasheet contains preliminary data; supplementary data will be published at a later date. Fairchild Semiconductor reserves the right to make changes at any time without notice to improve design.
No Identification Needed	Full Production	This datasheet contains final specifications. Fairchild Semiconductor reserves the right to make changes at any time without notice to improve design.
Obsolete	Not In Production	This datasheet contains specifications on a product that has been discontinued by Fairchild Semiconductor. The datasheet is printed for reference information only.